



**DRS UK**

**Premier Garage Doors**

**Compact Garage Doors**

**Extruded Security Window Shutters**

**Foam Filled Window Shutters**

**DRS PREMIER**

**Safety & quality never compromised**  
Trade catalogue & price list 2023/2024





## Company Introduction

DRS UK is based within Manor Park, Runcorn, Cheshire and were established in 2006. As trade suppliers only, DRS UK are committed to providing competitively priced products without compromising safety, quality or service.

## Warranty

DRS Premier Garage Doors and Window Shutters come complete with a 2 year guarantee on all manufactured parts, whilst the colour finish has a limited 10 year guarantee. Where applicable, the tubular motor carries a 5 year manufacturer's warranty.

Please note some marking may occur at the top of the concave side of the curtain over time. This is unavoidable and due to the rolling nature of the product and locking mechanism.

## Finishes Available Standard Colour Range









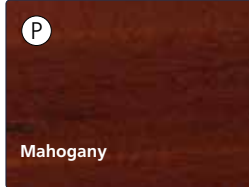
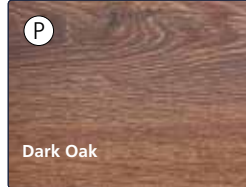
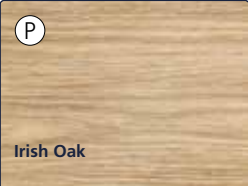
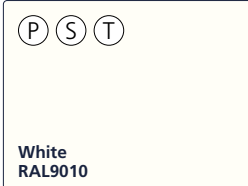
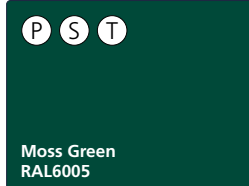
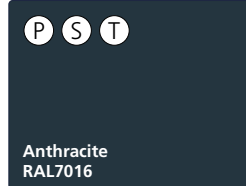

\*Guide section, endplates & canopy supplied colour co-ordinated at no extra cost

<p>(P) (C) (E) (W) (S)</p> <p>White RAL9010</p>	<p>(P) (C) (E) (W) (S)</p> <p>Brown RAL8019</p>	<p>(P) (C) (E) (W) (S)</p> <p>Fir Green RAL6009</p>	<p>(P) (C) (E) (W) (S)</p> <p>Black RAL9005</p>
<p>(P) (C) (S)</p> <p>Red RAL3004</p>	<p>(P) (C) (S)</p> <p>Blue RAL5011</p>	<p>(P) (C) (S)</p> <p>Beige RAL N/A</p>	<p>(P) (C) (E) (W) (S)</p> <p>Ivory RAL1015</p>
<p>(P) (C) (E) (W) (S)</p> <p>Alu. Metallic RAL9006</p>	<p>(P) (C) (E) (W) (S)</p> <p>Grey RAL7038</p>	<p>(P) (C) (E) (W) (S)</p> <p>Anthracite RAL7016</p>	<p>(P) (C) (S)</p> <p>Chartwell Green</p>
<p>(P) (S)</p> <p>Graphite RAL2100</p>	<p>(P) (C) (W)</p> <p>Golden Oak</p>	<p>(P) (C)</p> <p>Rosewood</p>	<p>(P) (S)</p> <p>Moss Green RAL6005</p>
<p>(P) (T)</p> <p>Cream White RAL9001</p>	<p>(P) (T)</p> <p>Traffic White RAL9016</p>	<p>(P) This profile colour is available in the 77mm Premier garage door range, see pages 4-5</p> <p>(C) This profile colour is available in the 55mm Compact garage door range shown on pages 6 - 7</p> <p>(E) This profile colour is available in the 44mm Extruded Window shutter range shown on pages 8 - 11</p> <p>(W) This profile colour is available in the 42mm Window shutter ranges shown on pages 12 - 15</p> <p>(S) This profile colour is available with colour coordinated guides and canopy.</p> <p>(T) Additional manufacturing time required for this colour</p>	

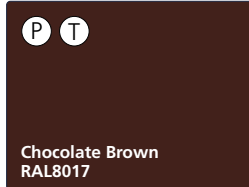
**For more details, please contact  
our sales team on:  
01928 571030 or [sales@drs-uk.com](mailto:sales@drs-uk.com)**

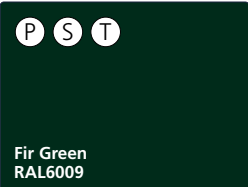
# Foil Finishes Range

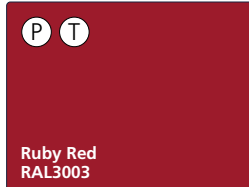
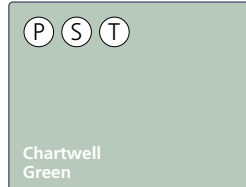
The printing process does not allow exact reproduction of the paint colours.  
If you are unsure of your colour choice please ask for a sample.

 Golden Oak	 Rosewood	 Mahogany	 Dark Oak
 Irish Oak	 White RAL9010	 Moss Green RAL6005	 Anthracite RAL7016
 Light Grey RAL7035	 Black Brown RAL8022	 Chocolate Brown RAL8017	 Grey RAL7038
 Fir Green RAL6009	 Basalt Grey RAL7012	 Ruby Red RAL3003	 Chartwell Green
 Red Wine RAL3005	 Slate Grey RAL7015	<p><b>P</b> This profile colour is available in the 77mm Premier garage door range, see pages 4-5</p> <p><b>S</b> This profile colour is available with colour coordinated guides and canopy.</p> <p><b>T</b> Additional manufacturing time required for this colour</p>	



## Index

Page

77mm Foam Filled Aluminium Premier Garage Door . . . . . 4-5

55mm Foam Filled Aluminium Compact Garage Door . . . . . 6-7

44mm Extruded Aluminium Electric and Spring Tensioned Security Window Shutter info . . . . . 8

44mm Extruded Aluminium Electric and Spring Tensioned Security Window Shutter order forms . . . . . 10-11

42mm Foam Filled Aluminium Electric and Spring Tensioned Window Shutter info . . . . . 12

42mm Foam Filled Aluminium Electric and Spring Tensioned Window Shutter order forms . . . . . 14-15

Account Application Form . . . . . 16-17

Terms And Conditions . . . . . 18-19



DRS Premier is a brand name of Domestic Roller Shutters Ltd. Domestic Roller Shutters Ltd reserve the right to alter specifications to design and manufacture without notification. All specifications are correct at time of publication, errors and omissions excepted.



## Introduction

The 77mm roller shutter system is capable of achieving a maximum overall width of 5.0m (including guides) and a maximum overall height of 3.3m (including box).

All shutters are supplied with a pair of guides (up to 95mm) and a 300mm box as standard.

Standard stock colour shutters, non-wood effect, are supplied with colour coordinated guides, end plates and box as standard. The wood effect foil range is supplied with brown guides, end plates and box as standard, alternative colours are available on request.

Upon Request: Reduced 75mm heavy duty guide section in White & Brown. Alternative colours are available at an additional cost.



## Technical Information

### Standard Specification

Tubular motor with manual override (crank handle supplied)

**QUALKIT Remote** (see picture above)

Remote control kit c/w 2 transmitters, courtesy light and push button\*

Wireless Optical Safety Edge System\*

Safety brake

Auto locks

Full canopy

90-deg UVJ (externally mounted to the 45-deg section of the canopy)

Pre-drilled guides (optional)

\*Items supplied pre-wired complete with mains cable and plug as standard.

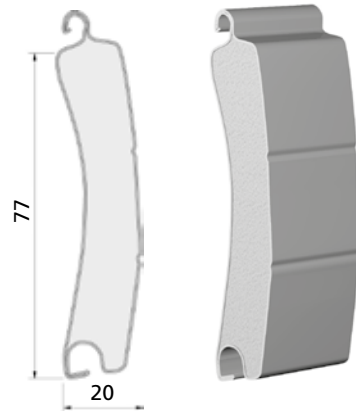

### Standard Component Details

#### Lath

77mm x 20mm foam filled aluminium  
Certified U Value of 4.73W/m<sup>2</sup> K

#### Heavy Duty Bottom Rail

78mm x 20mm aluminium c/w rubber weatherstrip

#### Heavy Duty Guide Section

Up to 95mm x 34mm aluminium

#### Heavy Duty End Plate

300mm aluminium with 45° chamfered edge

#### Canopy

300mm aluminium with 45° chamfered edge



# 77mm Foam Filled Aluminium Premier Garage Door Order Form

<b>Company Name</b>		<b>Order Number</b>		<b>Reference</b>	
<b>Address</b>		<b>Del. Address</b>			
		(If different to invoice address)			
<b>Postcode</b>		<b>Postcode</b>			
<b>Tel Number</b>		<b>Fax Number</b>		<b>Contact Name</b>	
				<b>Tel Number</b>	
<b>Email Address</b>		<b>Email Address</b>			

**Please Note:**  
We manufacture all products to the exact sizes provided.

Quantity	Door Size (Please provide accurate measurements in mm)				Colour Required		
	Opening Width (Between guides)	Guide Height (Clear opening will be 100mm less)	Overall Width (Including guides)	Overall Height (Including box)	Curtain	Canopy (Including endplates)	Guides
D1							
D2							
D3							
D4							
D5							

		Guides to be Predrilled		Yes	No			
Motor Handling (As viewed from inside looking out)		Left Hand Guide		Right Hand Guide		Optional Extras / Upgrades		
Left	Right	Face Fix	Side Fix	Face Fix	Side Fix	Low Level Override	Battery Back Up	Photocell and Reflector Kit
D1								
D2								
D3								
D4								
D5								

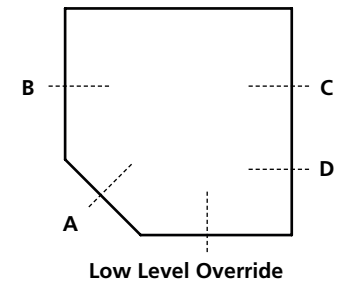

Override Position (Please specify)			
D1		D4	
D2		D5	
D3			

<b>Signed</b>	
<b>Date</b>	

## Introduction

The 55mm roller shutter system is capable of achieving a maximum overall width of 3.5m (including guides) and a maximum overall height of 2.85m (including box).  
All shutters are supplied with 66mm guides and 205 or 250mm box as standard depending on height.  
*Standard stock colour shutters are supplied with colour coordinated guides, end plates and box as standard.*



## Technical Information

### Standard Specification

Tubular motor with manual override (crank handle supplied)

**QUALKIT Remote** (see picture above)

Remote control kit c/w 2 transmitters, courtesy light and push button\*

Wireless Optical Safety Edge System\*

Safety brake

Auto locks

Full canopy

90-deg UVJ (externally mounted to the 45-deg section of the canopy)

Pre-drilled guides (optional)

\*Items supplied pre-wired complete with mains cable and plug as standard.

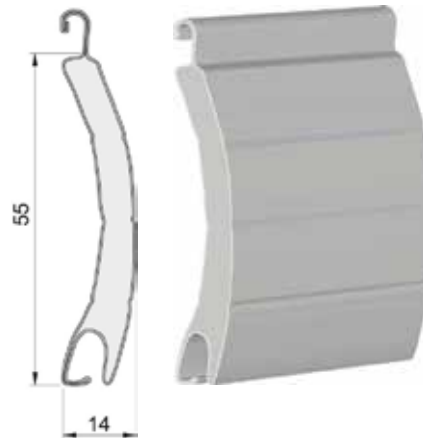

### Standard Component Details

**Lath**

55mm x 14mm foam filled aluminium

**Heavy Duty Bottom Rail**

55mm x 14mm aluminium

**Heavy Duty Guide Section**

66mm x 27mm aluminium

**Heavy Duty End Plate**

205mm aluminium with 45° chamfered edge

**Canopy**

205mm aluminium with 45° chamfered edge

250mm End Plates & Canopy supplied 90° square  
(White or Brown)

\*250mm Square Box Available in White or Brown As Standard

Powder Coating Service Available - Please Feel Free To Contact Us For A Quotation

**Ideal for installations where headroom is limited**

# 55mm Foam Filled Aluminium Compact Garage Door Order Form

<b>Company Name</b>		<b>Order Number</b>		<b>Reference</b>	
<b>Address</b>		<b>Del. Address</b>			
		(If different to invoice address)			
<b>Postcode</b>		<b>Postcode</b>			
<b>Tel Number</b>		<b>Fax Number</b>		<b>Contact Name</b>	
				<b>Tel Number</b>	
<b>Email Address</b>		<b>Email Address</b>			

**Please Note:**  
We manufacture all products to the exact sizes provided.

Quantity	Door Size (Please provide accurate measurements in mm)				Colour Required		
	Opening Width (Between guides)	Guide Height (Clear opening will be 85mm less)	Overall Width (Including guides)	Overall Height (Including box)	Curtain	Canopy (Including endplates)	Guides
D1							
D2							
D3							
D4							
D5							

		Guides to be Predrilled		Yes	No			
Motor Handling (As viewed from inside looking out)		Left Hand Guide		Right Hand Guide		Optional Extras / Upgrades		
Left	Right	Face Fix	Side Fix	Face Fix	Side Fix	Low Level Override	Battery Back Up	Photocell and Reflector Kit
D1								
D2								
D3								
D4								
D5								

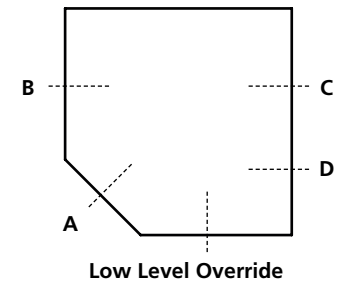

Override Position (Please specify)			
D1		D4	
D2		D5	
D3			

<b>Signed</b>	
<b>Date</b>	

## Electric Shutters Introduction

The 44mm roller shutter system is capable of achieving a maximum overall width of 4m (including guides) and a maximum overall height of 3.250m (including box).

All shutters are supplied with 66mm guides and 150, 165, 180, 205 or 250mm box as standard depending on height.

Standard stock colour shutters are supplied with colour coordinated guides, end plates and box as standard.

Alternative colour shutters are available at an additional cost.

## Technical Information

### Standard Specification

- Non-manual override tubular motor
- Auto locks
- Full canopy
- Pre-drilled guides

## Standard Component Details

### Heavy Duty Lath

44mm x 9.5mm extruded aluminium

### Heavy Duty Bottom Rail

47mm x 8.5mm aluminium

### Heavy Duty Guide Section

66mm x 22mm aluminium

### Heavy Duty End Plate

150/165/180/205mm aluminium with 45° chamfered edge

### Canopy

150/165/180/205mm aluminium with 45° chamfered edge

250mm End Plates & Canopy supplied 90° square  
(White or Brown)

Maximum Guide Height	950mm	150mm Box
	1450mm	165mm Box
	1800mm	180mm Box
	2450mm	205mm Box
	3000mm	250mm Box

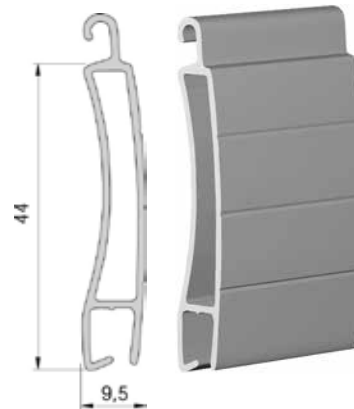

**These Products Are Available Punched, Punched & Glazed, Brick Bond or In-Line**

Contact our sales department on  
**01928 571030** for a quotation



## Spring Tensioned Shutters Introduction

The 44mm roller shutter system is capable of achieving a maximum overall width of 3m (including guides) and a maximum overall height of 2.855m (including box).

All shutters are supplied with 66mm guides and 150, 165, 180 or 205mm box as standard depending on height.

Standard stock colour shutters are supplied with colour coordinated guides, end plates and box as standard.

Alternative colour shutters are available at an additional cost.

## Technical Information

### Standard Specification

- Heavy duty pre-tensioned spring
- T-springs
- Bottom rail lock (safe lock - 3 keys)
- Bottom rail stops and conical stops
- Handles
- Full canopy
- Pre-drilled guides

## Standard Component Details

### Heavy Duty Lath

44mm x 9.5mm extruded aluminium

### Heavy Duty Bottom Rail

47mm x 8.5mm aluminium

### Heavy Duty Guide Section

66mm x 22mm aluminium

### Heavy Duty End Plate

150/165/180/205mm aluminium with 45° chamfered edge

### Canopy

150/165/180/205mm aluminium with 45° chamfered edge



Maximum Guide Height	1150mm	150mm Box
	1650mm	165mm Box
	1900mm	180mm Box
	2650mm	205mm Box





**Hardcopy and PDF  
version available.**

# 44mm Extruded Aluminium Electric Security Window Shutter Order Form

<b>Company Name</b>		<b>Order Number</b>		<b>Reference</b>	
<b>Address</b>		<b>Del. Address</b>			
		(If different to invoice address)			
<b>Postcode</b>		<b>Postcode</b>			
<b>Tel Number</b>		<b>Fax Number</b>		<b>Contact Name</b>	
				<b>Tel Number</b>	
<b>Email Address</b>		<b>Email Address</b>			

**Please Note:**  
We manufacture all products to the exact sizes provided.

Quantity	Window Size (Please provide accurate measurements in mm)				Colour Required (Please Specify Colour & RAL / BS Number If Powder Coating Is Required)		
	Opening Width (Between guides)	Guide Height (Clear opening will be 50mm less)	Overall Width (Including guides)	Overall Height (Including box)	Curtain	Canopy (Including endplates)	Guides
S1							
S2							
S3							
S4							
S5							

		Guides to be Predrilled		Yes	No			
Motor Handling (As viewed from inside looking out)		Left Hand Guide		Right Hand Guide		Optional Extras / Upgrades		
Left	Right	Face Fix	Side Fix	Face Fix	Side Fix	Manual Override	UVJ Required	Safety Brake
S1								
S2								
S3								
S4								
S5								

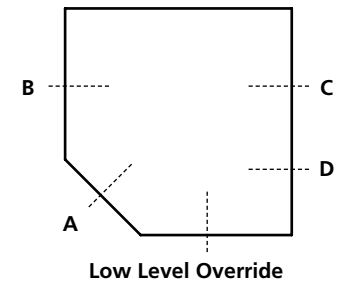

Override Position (Please specify)			
S1		S4	
S2		S5	
S3			

<b>Signed</b>	
<b>Date</b>	

# 44mm Extruded Aluminium Spring Tensioned Security Window Shutter Order Form

<b>Company Name</b>		<b>Order Number</b>		<b>Reference</b>	
<b>Address</b>		<b>Del. Address</b>			
		(If different to invoice address)			
<b>Postcode</b>		<b>Postcode</b>			
<b>Tel Number</b>		<b>Fax Number</b>		<b>Contact Name</b>	
				<b>Tel Number</b>	
<b>Email Address</b>		<b>Email Address</b>			

**Please Note:**  
We manufacture all products to the exact sizes provided.

Quantity	Window Size (Please provide accurate measurements in mm)				Colour Required (Please Specify Colour & RAL / BS Number If Powder Coating Is Required)		
	Opening Width (Between guides)	Guide Height (Clear opening will be 50mm less)	Overall Width (Including guides)	Overall Height (Including box)	Curtain	Canopy (Including endplates)	Guides
S1							
S2							
S3							
S4							
S5							

		Guides to be Predrilled		Yes	No
Bottom Rail Locking Position (Internal denotes endplates facing you)		Left Hand Guide		Right Hand Guide	
Internal	External	Face Fix	Side Fix	Face Fix	Side Fix
S1					
S2					
S3					
S4					
S5					

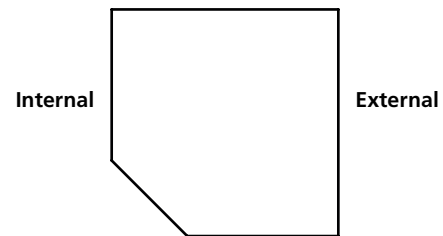

**Please Note**  
The bottom rail lock is operable from both sides of the shutter, however is only secure on one side. When stating locking position, the secure side will always be as advised.

<b>Signed</b>	
<b>Date</b>	

## Electric Shutters Introduction

The 42mm roller shutter system is capable of achieving a maximum overall width of 3m (including guides) and a maximum overall height of 3.250m (including box).  
 All shutters are supplied with 53mm guides and 150, 165, 180, 205 or 250mm box as standard depending on height.  
 Standard stock colour shutters are supplied with colour coordinated guides, end plates and box as standard.

## Technical Information

### Standard Specification

- Non-manual override tubular motor
- Auto locks
- Full canopy
- Pre-drilled guides

### Standard Component Details

- Lath**  
42mm x 9.5mm foam filled aluminium
- Heavy Duty Bottom Rail**  
47mm x 8.5mm aluminium
- Guide Section**  
53mm x 22mm aluminium
- Heavy Duty End Plate**  
150/165/180/205mm aluminium with 45° chamfered edge
- Canopy**  
150/165/180/205mm aluminium with 45° chamfered edge  
250mm End Plates & Canopy supplied 90° square  
(White or Brown)

Maximum Guide Height	950mm	150mm Box
	1450mm	165mm Box
	1800mm	180mm Box
	2450mm	205mm Box
	3000mm	250mm Box

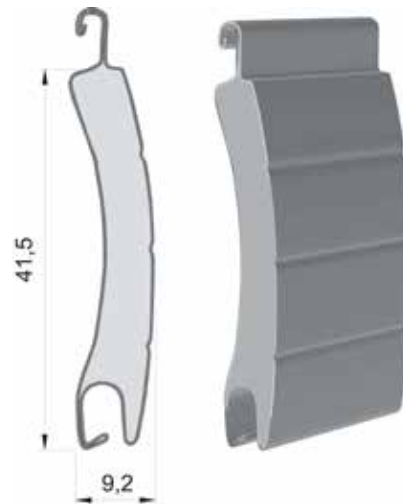

## Spring Tensioned Shutters Introduction

The 42mm roller shutter system is capable of achieving a maximum overall width of 3m (including guides) and a maximum overall height of 2.855m (including box).  
 All shutters are supplied with 53mm guides and 150, 165, 180 or 205mm box as standard depending on height.  
 Standard stock colour shutters are supplied with colour coordinated guides, end plates and box as standard.

## Technical Information

### Standard Specification

- Heavy duty pre-tensioned spring
- T-springs
- Bottom rail lock (safe lock - 3 keys)
- Bottom rail stops and conical stops
- Handles
- Full canopy
- Pre-drilled guides

### Standard Component Details

- Lath**  
42mm x 9.5mm foam filled aluminium
- Heavy Duty Bottom Rail**  
47mm x 8.5mm aluminium
- Guide Section**  
53mm x 22mm aluminium
- Heavy Duty End Plate**  
150/165/180/205mm aluminium with 45° chamfered edge
- Canopy**  
150/165/180/205mm aluminium with 45° chamfered edge



Maximum Guide Height	1150mm	150mm Box
	1650mm	165mm Box
	1900mm	180mm Box
	2650mm	205mm Box



# EURODRIVE

Available Accessories **CONTROLS**

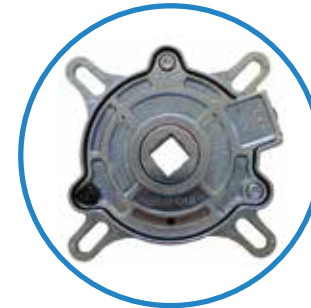
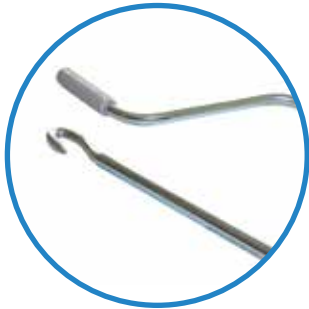

# 42mm Foam Filled Aluminium Electric Window Shutter Order Form

<b>Company Name</b>		<b>Order Number</b>		<b>Reference</b>	
<b>Address</b>		<b>Del. Address</b>			
		(If different to invoice address)			
<b>Postcode</b>		<b>Postcode</b>			
<b>Tel Number</b>		<b>Fax Number</b>		<b>Contact Name</b>	
				<b>Tel Number</b>	
<b>Email Address</b>		<b>Email Address</b>			

**Please Note:**  
We manufacture all products to the exact sizes provided.

Quantity	Window Size (Please provide accurate measurements in mm)				Colour Required		
	Opening Width (Between guides)	Guide Height (Clear opening will be 50mm less)	Overall Width (Including guides)	Overall Height (Including box)	Curtain	Canopy (Including endplates)	Guides
S1							
S2							
S3							
S4							
S5							

		Guides to be Predrilled		Yes	No			
Motor Handling (As viewed from inside looking out)		Left Hand Guide		Right Hand Guide		Optional Extras / Upgrades		
Left	Right	Face Fix	Side Fix	Face Fix	Side Fix	Manual Override	UVJ Required	Safety Brake
S1								
S2								
S3								
S4								
S5								

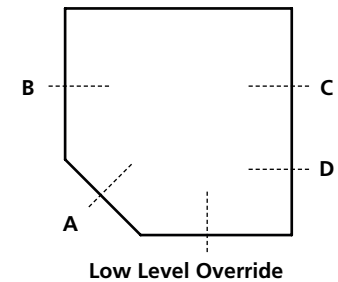

Override Position (Please specify)			
S1		S4	
S2		S5	
S3			

<b>Signed</b>	
<b>Date</b>	

# 42mm Foam Filled Aluminium Spring Tensioned Window Shutter Order Form

<b>Company Name</b>		<b>Order Number</b>		<b>Reference</b>	
<b>Address</b>		<b>Del. Address</b>			
		(If different to invoice address)			
<b>Postcode</b>		<b>Postcode</b>			
<b>Tel Number</b>		<b>Fax Number</b>		<b>Contact Name</b>	
				<b>Tel Number</b>	
<b>Email Address</b>		<b>Email Address</b>			

**Please Note:**  
We manufacture all products to the exact sizes provided.

Quantity	Window Size (Please provide accurate measurements in mm)				Colour Required		
	Opening Width (Between guides)	Guide Height (Clear opening will be 50mm less)	Overall Width (Including guides)	Overall Height (Including box)	Curtain	Canopy (Including endplates)	Guides
S1							
S2							
S3							
S4							
S5							

		Guides to be Predrilled		Yes	No
Bottom Rail Locking Position (Internal denotes endplates facing you)		Left Hand Guide		Right Hand Guide	
Internal	External	Face Fix	Side Fix	Face Fix	Side Fix
S1					
S2					
S3					
S4					
S5					

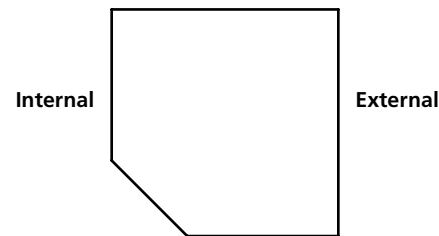

**Please Note**  
The bottom rail lock is operable from both sides of the shutter, however is only secure on one side. When stating locking position, the secure side will always be as advised.

<b>Signed</b>	
<b>Date</b>	

# Account Application Form

<b>Company Name:</b>		<b>Delivery Address</b>		<b>Accounts Tel:</b>	
<b>Invoicing Address:</b>				<b>Accounts Fax:</b>	
				<b>Purchasing Tel:</b>	
				<b>Purchasing Fax:</b>	
				<b>Email:</b>	
<b>Postcode:</b>		<b>Postcode:</b>		<b>Contact Name:</b>	

<b>Number of years trading as above:</b>		<b>Type of Business:</b>	<input type="checkbox"/> PLC	<b>Bank Name &amp; Address:</b>	
<b>Company Registration Number:</b>		<b>(Circle one)</b>	<input type="checkbox"/> Ltd Company		
<b>Amount of Credit Required:</b> <i>NOTE, if left blank it will be assumed you do not need a credit account</i>			<input type="checkbox"/> Partnership		
			<input type="checkbox"/> Sole Trader		
<b>VAT Registration Number:</b>				<b>Account Number:</b>	
				<b>Sort Code:</b>	

<b>Name &amp; Address of Trade Reference 1</b>		<small>(Not Direct Competitors Please)</small>	
	<b>Postcode:</b>		
<b>Tel:</b>		<b>Fax:</b>	
<b>Accounts Email:</b>			

<b>Name &amp; Address of Trade Reference 2</b>		<small>(Not Direct Competitors Please)</small>	
	<b>Postcode:</b>		
<b>Tel:</b>		<b>Fax:</b>	
<b>Accounts Email:</b>			

**Name & Address of Proprietors or Partners:** \_\_\_\_\_ In the case of sole traders or partnerships this section must be completed.

<b>Address:</b>	
	<b>Postcode:</b>
<b>Tel:</b>	<b>Fax:</b>

<b>Address:</b>	
	<b>Postcode:</b>
<b>Tel:</b>	<b>Fax:</b>

I/We agree to accept the supply of your goods upon the terms & conditions of Domestic Roller Shutters Ltd, a copy of which is attached.

<b>Signed:</b>		<b>Company Position:</b>	
<b>Name: (Block Capitals)</b>		<b>Date:</b>	



## Declaration and Data Protection Notice

I/We confirm that the information given in this Credit Account Application Form is in all respects true and accurate. I/We confirm that I/we have read and understood your terms and conditions of sale and I/we unconditionally accept that those terms and conditions shall be the only ones that apply to all sale contracts which I/we may conclude with you.

### **Data Protection Act 1998 Notice**

Words shown in italics are defined in the Data Protection Act 1998 (*"the Act"*).

Where I/we provide you with personal data (*"data"*), I/we understand that the data will be held securely in confidence and processed for the purpose of carrying out your business and associated activities (*"Activities"*). In considering my/our application, I/we accept that you may consult with and disclose the data to credit reference agencies, banks, credit insurers and other responsible organisations outside your business that you have nominated (*"third parties"*), and that such third parties may process the data. I/we understand that under the Act I/we have a right to know what data you hold on me/us if I/we apply to you in writing and pay the applicable fee.

Authorised Signature of Applicant(s):

Date:

Printed Name of Signatory:

Position within the Business:

Company Stamp (if available)

## 1. DEFINITIONS

In these conditions Domestic Roller Shutters Ltd is referred to as 'the Company' and the person, firm or company placing the order or otherwise dealing with the Company as 'the Customer'. The reference to 'the Goods' means any goods or services ordered by the Customer from the Company.

## 2. HEADINGS

The headings to these Terms and Conditions of Sale are for convenience only and shall have no effect on the interpretation thereof.

## 3. ADVICE

- i) These terms and conditions represent the entire agreement made between the Company and the Customer and exclude any other terms and/or conditions which may be inconsistent therewith.
- ii) No variation substitution addition or alteration to these terms shall be permitted.
- iii) No employee salesman or agent or other representative howsoever of the Company has any authority whether actual presumed or otherwise to vary or delete or add to any of these terms and conditions nor to make any representations pertaining to the goods their delivery use or suitability nor to give any advice or warranty in respect thereof and any view opinion or advice expressed by any such person in respect of the goods their delivery use or suitability shall not be considered the view opinion advice of the Company.
- iv) The Company shall be under no liability whatsoever in respect of any advice it has given or views it has expressed to a Customer whether or not such advice is given or such views expressed at the Customer's request.
- v) The Customer acknowledges that he was not induced to contract as a result of any oral representation of whatever nature made to him by any servant or agent of the company.

## 4. GENERAL

- i) All prices quoted by the Company are based upon these conditions and reflect the limitations upon the Company's liability which they contain. Any quotation is merely an invitation to treat and no order whether based on a quotation or not shall create a binding contract between the Company and the Customer until the Company has expressly accepted such order in writing.
- ii) These conditions shall apply to all quotations given by the Company and all contracts made between the Company and the Customer and shall supersede and over-ride any other terms and conditions proposed or stipulated in the order or otherwise by the Customer.

## 5. ACCEPTANCE

The Customer's written order can only be validly accepted by the signature of a person duly authorised on behalf of the Company.

## 6. PRICES

- i) All prices quoted by the Company are exclusive of Value Added Tax, and are subject to variation without notice any time prior to the Customer's acceptance.
- ii) Prices are quoted by the Company for the quantities of goods or other services specified and it shall only apply to orders for quantities or those services without alteration or amendment.
- iii) Packing handling and delivery will be charged as an extra unless otherwise stated.

## 7. PAYMENT

- i) Unless otherwise agreed by the Company payment of the full price (including Value Added Tax and any other charges) of the goods or services shall be 30 days from date of invoice.
- ii) Where the Company delivers part of an order the Company shall nevertheless be entitled to payment for that part.
- iii) If the Customer fails to make payment due to the Company on the due date the Customer shall pay the Company the value of all goods delivered and all work done as if the same were immediately due and the Company may suspend the production of further goods for the Customer and recover from the Customer the cost of such production any materials purchased as a result of the Customer's order and any consequential loss of profit and the Company shall be under no obligation to continue such production unless and until the Customer has paid in advance the total cost or anticipated cost of the order including the value of any other goods delivered to the Customer by the Company.
- iv) If any sum shall remain unpaid after becoming due, the amount unpaid calculated from the due date shall bear interest at the rate of 3 per cent per month, such interest to accrue from day to day.

## 8. DESIGNS AND DRAWINGS

- i) Where the Company prepares designs or drawings to meet the Customer's requirements:-
  - a) the Customer shall approve such designs and drawings in writing and until such approval has been given the Company shall be under no liability to the Customer and the time for delivery shall not begin to run;
  - b) the Company shall not in any event be responsible for the correct functioning of the goods supplied in accordance with the designs or drawings the responsibility shall lie with the Customer pursuant to the Customer's approval of the said designs or drawings.
- ii) Where the goods are manufactured or supplied to designs submitted by the Customer the Company shall be under no liability for the correct functioning of the goods in accordance with such designs.
- iii) Where the Company prepares such designs or drawings to meet the Customer's requirements and the Customer thereafter fails to contract with the Company for the provision of goods and/or services in accordance with the said designs or drawings the Company shall be entitled to charge the Customer a reasonable fee in respect of the preparation of the said designs and drawings.

## 9. OWNERSHIP

- i) All goods delivered by the Company to or to the order of the Customer shall remain the property of the Company until all sums due to the Company from the Customer whether or not in respect of such Goods have been paid in full.
- ii) Upon the occurrence of any of the events specified in Clause 16 hereof the Company shall be entitled to immediate possession of all goods in the custody or under the control of the Customer. The Customer shall hold such unused or unmixed goods at the disposal of the Company who shall be entitled to enter upon any land or premises of the Customer or where the goods are situated for the purposes of recovering the same.
- iii) Unless otherwise agreed in writing any drawings, designs, diagrams or other items used in the production of the goods shall remain with and be the property of the Company.

## 10. RISK

The risk in the goods shall pass to the Customer upon delivery whereupon the Customer shall insure the goods for their full reinstatement value for the benefit of the Company.

## 11 DELIVERY

- i) All prices quoted by the Company are for delivery ex of the Company's works. Where the Customer requires the Company to deliver or despatch the goods the Company may agree to do so and a separate charge will be made for such despatch or delivery.
- ii) Any time or date for the despatch or delivery of the goods or for the commencement or completion of any work whether specified in the contract or otherwise shall be taken as merely an estimate by the Company in good faith which the Company shall endeavour to fulfil but shall not be binding on the Company either as a term of contract or otherwise. In no circumstances shall the Company be liable for any loss or damage sustained by the Customer in consequence of any failure by the Company to adhere to such times or dates or in consequence of any delay in such despatch, delivery, commencement or completion however caused.
- iii) Any claim of the Customer that the Company has failed to despatch from its works the specified quantity of goods shall be made in writing not later than 3 days after receipt by the Customer of notification of such despatch by the Company. In no circumstances shall the Company be liable in default of notification within such period.

## 12 FORCE MAJEURE

In the event of war, invasion, act of foreign enemy, hostilities (whether war has been declared or not) civil war rebellion, revolution insurrection, riot, civil disturbance, fire, flood, explosion, accident, theft, climate conditions or shortage of material the Company shall be relieved of obligations incurred under this contract wherever and to the extent of the fulfilment of such obligations as are prevented, frustrated, impeded or delayed as a consequence of any such event or by any statute, rules, regulations, orders or requisitions issued by any Government, Council or other duly constituted authority or from strikes, lock outs, trade disputes (whether involving the Company's employees or other parties) or any other causes, whether or not of a like nature, beyond the Company's control.

## 13 GUARANTEE

- i) The Customer shall fully inspect examine and test the goods as soon as reasonably practicable and in any event within seven days of delivery by the Company.
- ii) The Customer will notify the Company in writing within seven days of the delivery of the goods by the Company of any defects or faults in the goods arising by reason of faulty workmanship or materials at the time of delivery and/or in respect of such defects or faults arising subsequent to delivery will notify the Company thereof in writing within seven days of such defects or faults arising and will upon being required so to do by the Company return the goods to the Company in such manner as required by the Company (the cost hereof may at the Company's option be refunded by the Company to the Customer) and in any event within seven days of being so required in default whereof all and/or any liability which the Company may have in respect of the goods howsoever shall cease.
- iii) Upon compliance by the Customer with Clause 13(i) and 13(ii) hereof the Company may at its option return replace or repair the goods or refund to the Customer the purchase price of the goods.
- iv) Without prejudice to the foregoing in respect of goods delivered in a defective condition by reason of having been damaged in transit the Customer will notify the Company thereof in writing within seven days of delivery and will return the goods to the Company within fourteen days of delivery (the cost whereof may at the Company's option be refunded by the Company to the Customer) whereupon the Company may at its option replace or repair the goods or refund to the Customer the purchase price of the goods.

- v) Save where the Customer complies with the requirements of Clause 13 (i) (ii) (iv) hereof whichever may be applicable the Company shall have no liability howsoever arising in respect of any defects alleged with respect to the goods.
- vi) The Company shall, in any event, have no liability or responsibility in respect of any defects or faults in the goods howsoever arising where such defects or defaults have not been notified to the Company in writing (and/or where such goods have not been returned to the Company if so required) within twelve months of the date of the delivery by the Company to the Customer of the goods.

## 14 CANCELLATION OF ORDER

Orders placed by the Customer are not subject to cancellation wholly or in part except with the written consent of the Company. Such consent will usually be given upon terms that the Customer shall reimburse the Company for any loss expense and time spent occasioned by the cancellation. The usual charge shall be 15% of the order value however this may be varied at the sole discretion of the Company.

## 15 SEPARATE CONTRACTS

Each delivery or part delivery of an order by the Company shall be treated as a separate contract and failure on the part of the Company to make any delivery or part delivery shall not affect or vitiate this contract with regard to other deliveries.

## 16 DEFAULT OF THE CUSTOMER

- i) If the Customer shall make default in or commit a breach of the terms or conditions of any contract with the Company, or if any distress or execution shall be levied upon the Customer's property or assets, or if the Customer shall make or offer to make any arrangement or composition with creditors, or commit any act of bankruptcy, or if any petition or receiving order in bankruptcy shall be presented or made against him, or a Statutory Demand is served on him, or if the Customer is a limited company and any resolution or petition to wind up such Company's business shall be passed or presented, or if a Receiver of such Company's undertaking, property or assets or any part thereof shall be appointed, the Company shall have right without notice to the Customer and without prejudice to any other claims or rights the Company may make or exercise to determine all or any of its contracts with the Customer.
- ii) If it should come to the notice of the Company that any work done or any goods to be supplied under this contract infringe or are alleged to infringe any patent registered design, copyright, or other rights in the manufacture of the goods then the Company shall have the right to cease the manufacture of these goods and to be bound by this contract and the Customer shall indemnify the Company against the Company for such infringement or alleged infringement or for royalties, and against all costs, expenses and other payments arising therefrom and shall pay to the Company the value of work done on and the materials used in the manufacture of the goods prior to such cessation of manufacture.

## 17 WAIVER

Unless otherwise specifically agreed in writing, no concession payment, delivery or any action or omission by the Company shall constitute or be deemed to constitute any waiver of its rights hereunder in respect of any existing or future contract.

## 18 PROPER LAW AND JURISDICTION

These conditions and all contracts shall be governed by and construed in accordance with the Law of England.



**Safety & quality never compromised**

Unit 1 Rokeby Court, Manor Park, Runcorn, Cheshire, WA7 1RW  
Tel: 01928 571030 Fax: 01928 571940

[sales@drs-uk.com](mailto:sales@drs-uk.com) [www.drs-uk.com](http://www.drs-uk.com)